

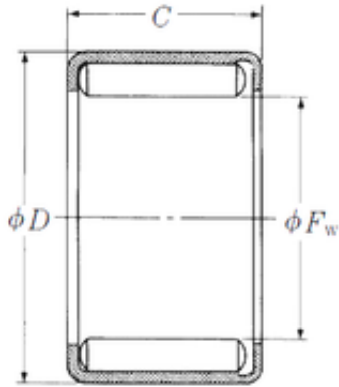

# NTN DRIVESHAFT ANDERSON, INC.

## NSK Y-128 needle roller bearings



Bearing No. Y-128

Size	19.05x25.4x12.7 mm
Bore Diameter	19,05 mm
Outer Diameter	25,4 mm
Width	12,7 mm
Fw	19,05 mm
D	25,4 mm
C	12,7 mm
Weight	0,017 Kg
Basic dynamic load rating (C)	10,8 kN

Y-128 Bearing 2D drawings and 3D CAD models